

Thermostat filaire pour commande de chauffage  
 Fixed wire thermostat for heating control  
 Termostato digital filar para calefacción  
 Termostato per regolare il riscaldamento  
 Drahtgebundener Thermostat zur Heizungssteuerung  
 Termostat elektroniczny do sterowania ogrzewaniem  
 Проводной термостат для управления отоплением

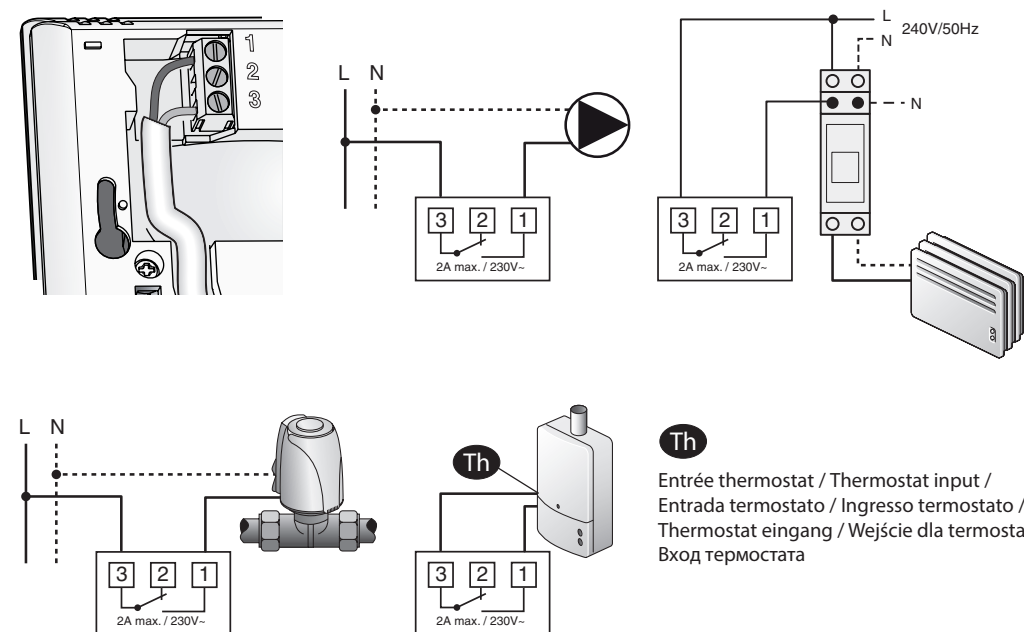

|  |                              |
|--|------------------------------|
|  | 2 x 1,5V LR03 - AAA Alkaline |
|  |                              |
|  | 2 A max., 230V~ (Type 1.C)   |
|  | -5°C / +40°C                 |
|  | 80 x 80 x 23 mm              |
|  | IP 30                        |
|  | 2014/30/UE et 2014/35/UE     |

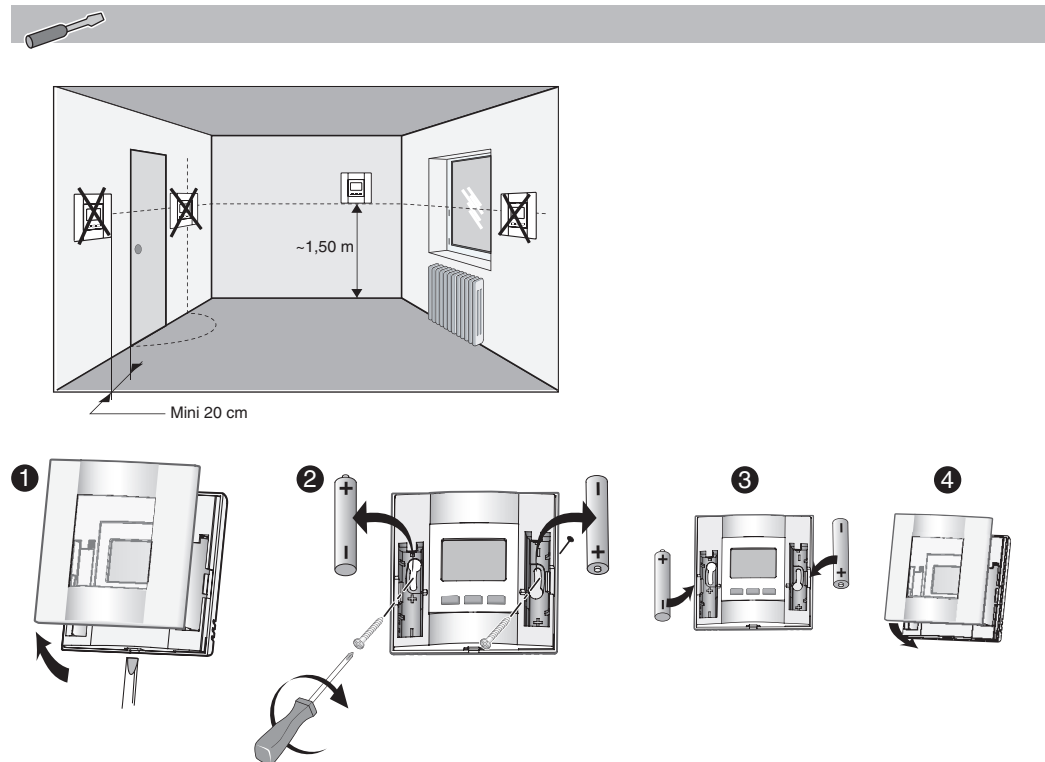

**Th**  
 Entrée thermostat / Thermostat input /  
 Entrada termostato / Ingresso termostato /  
 Thermostat eingang / Wejście dla termostatu,  
 Вход термостата

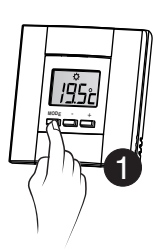

MODE > 10"

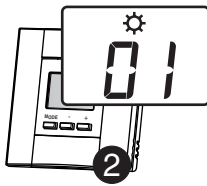

Température de consigne  
Set-point temperature  
Temperatura de consigna  
Temperatura di riferimento  
Solltemperatur  
Temperatura zadana  
Заданная температура

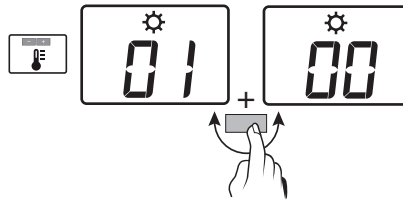

Température ambiante  
Room temperature  
Temperatura de ambiente  
Temperatura ambiente  
Raumtemperatur  
Temperatura otoczenia  
Температура в помещении

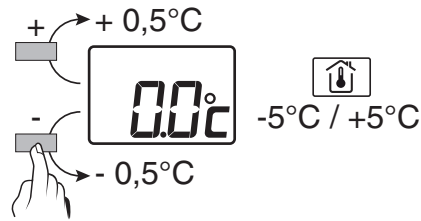
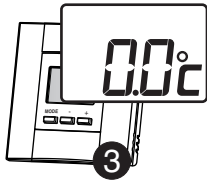
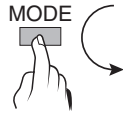

Réglage de la mesure de température de + ou - 5°C  
Temperature measurement adjustment of + or - 5°C  
Ajuste de la medida de temperatura de + o - 5°C  
Regolazione della misura di temperatura da + o - 5°C  
Verstellung der Temperaturmessung um + oder - 5°C  
Regulacja wartości temperatury od + do -5°C  
Изменение измеренной температуры на + или - 5°C

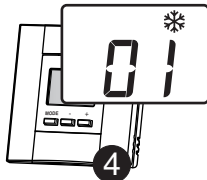
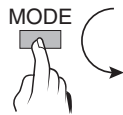

Clavier déverrouillé  
Keypad unlocked  
Teclado desbloqueado  
Tastiera sbloccata  
Tastatur freigegeben  
Klawiatura odblokowana  
Кнопки разблокированы

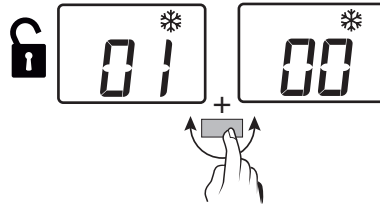

Clavier verrouillé  
Keypad locked  
Teclado bloqueado  
Tastiera bloccata  
Tastatur gesperrt  
Klawiatura zablokowana  
Кнопки заблокированы

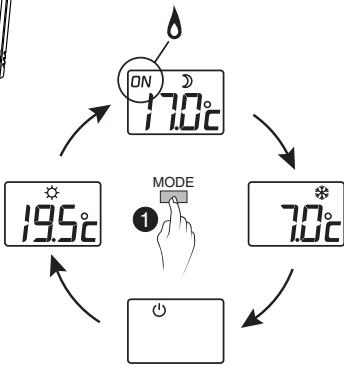
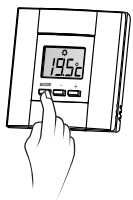
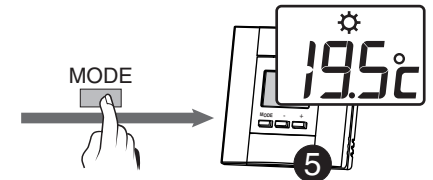

- ⚙ Confort, Comfort, Conforto, Komfort, Комфорт
- ⤴ Economie, Set-back, Economía, Risparmio, Sparbetrieb, Oszczędny, Экономичный режим
- \* Hors-gel, Frost-protection, Anti-helada, Antigelo, Frostschutz, Zamrażaniu, Защита от замерзания

